

Inspiron 24

3000 Series

Service Manual

Computer Model: Inspiron 24–3452
Regulatory Model: W12C
Regulatory Type: W12C002

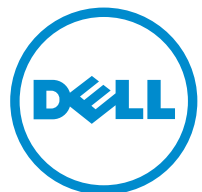

Notes, cautions, and warnings



NOTE: A NOTE indicates important information that helps you make better use of your computer.



CAUTION: A CAUTION indicates either potential damage to hardware or loss of data and tells you how to avoid the problem.



WARNING: A WARNING indicates a potential for property damage, personal injury, or death.

Copyright © 2015 Dell Inc. All rights reserved. This product is protected by U.S. and international copyright and intellectual property laws. Dell™ and the Dell logo are trademarks of Dell Inc. in the United States and/or other jurisdictions. All other marks and names mentioned herein may be trademarks of their respective companies.

2015 - 07

Rev. A00

Contents

Before working inside your computer.....	8
Before you begin	8
Safety instructions.....	9
Recommended tools.....	10
After working inside your computer.....	11
Technical overview.....	12
Inside view of your computer.....	12
Removing the stand assembly.....	13
Procedure.....	13
Replacing the stand assembly.....	15
Procedure.....	15
Removing the back cover.....	16
Prerequisites.....	16
Procedure.....	16
Replacing the back cover.....	18
Procedure.....	18
Post-requisites.....	18
Removing the optical drive.....	19
Prerequisites.....	19
Procedure.....	19
Replacing the optical drive.....	22
Procedure.....	22
Post-requisites.....	22

Removing the hard drive.....	23
Prerequisites.....	23
Procedure.....	23
Replacing the hard drive.....	26
Procedure.....	26
Post-requisites.....	26
Removing the memory module.....	27
Prerequisites.....	27
Procedure.....	27
Replacing the memory module.....	29
Procedure.....	29
Post-requisites.....	30
Removing the wireless card.....	31
Prerequisites.....	31
Procedure.....	31
Replacing the wireless card.....	33
Procedure.....	33
Post-requisites.....	34
Removing the heat sink.....	35
Prerequisites.....	35
Procedure.....	35
Replacing the heat sink.....	37
Procedure.....	37
Post-requisites.....	37

Removing the fan.....	38
Prerequisites.....	38
Procedure.....	38
Replacing the fan.....	40
Procedure.....	40
Post-requisites.....	40
Removing the coin-cell battery.....	41
Prerequisites.....	41
Procedure.....	42
Replacing the coin-cell battery.....	43
Procedure.....	43
Post-requisites.....	43
Removing the microphone.....	44
Prerequisites.....	44
Procedure.....	44
Replacing the microphone.....	46
Procedure.....	46
Post-requisites.....	46
Removing the camera.....	47
Prerequisites.....	47
Procedure.....	47
Replacing the camera.....	49
Procedure.....	49
Post-requisites.....	49

Removing the system board.....	50
Prerequisites.....	50
Procedure.....	50
Replacing the system board.....	53
Procedure.....	53
Post-requisites.....	53
Removing the VESA-mount bracket.....	55
Prerequisites.....	55
Procedure.....	55
Replacing the VESA-mount bracket.....	57
Procedure.....	57
Post-requisites.....	57
Removing the speaker cover.....	58
Prerequisites.....	58
Procedure.....	58
Replacing the speaker cover.....	60
Procedure.....	60
Post-requisites.....	60
Removing the speakers.....	61
Prerequisites.....	61
Procedure.....	61
Replacing the speakers.....	63
Procedure.....	63
Post-requisites.....	63





Removing the control-buttons board.....	64
Prerequisites.....	64
Procedure.....	64
Replacing the control-buttons board.....	66
Procedure.....	66
Post-requisites.....	66
Removing the display assembly.....	67
Prerequisites.....	67
Procedure.....	68
Replacing the display assembly.....	72
Procedure.....	72
Post-requisites.....	72
Removing the rubber feet.....	74
Prerequisites.....	74
Procedure.....	74
Replacing the rubber feet.....	76
Procedure.....	76
Post-requisites.....	76
Flashing the BIOS.....	77

Before working inside your computer

 **CAUTION:** To avoid damaging the components and cards, handle them by their edges and avoid touching pins and contacts.









 **NOTE:** The images in this document may differ from your computer depending on the configuration you ordered.

Before you begin

- 1 Save and close all open files and exit all open applications.
 - 2 Shut down your computer.
 - Windows 10: Click or tap **Start** →  **Power** → **Shut down**.
 - Windows 8.1: On the **Start** screen, click or tap the power icon  → **Shut down**.
 - Windows 7: Click or tap **Start** → **Shut down**.
-  **NOTE:** If you are using a different operating system, see the documentation of your operating system for shut-down instructions.
- 3 Disconnect your computer and all attached devices from their electrical outlets.
 - 4 Disconnect all cables such as telephone cables, network cables and so on, from your computer.
 - 5 Disconnect all attached devices and peripherals, such as keyboard, mouse, monitor, and so on, from your computer.
 - 6 Remove any media card and optical disc from your computer, if applicable.
 - 7 After the computer is unplugged, press and hold the power button for 5 seconds to ground the system board.
-  **CAUTION:** Place the computer on a flat, soft and clean surface to avoid scratching the display.
- 8 Place the computer face down.

Safety instructions

Use the following safety guidelines to protect your computer from potential damage and ensure your personal safety.

-  **WARNING:** Before working inside your computer, read the safety information that shipped with your computer. For more safety best practices, see the Regulatory Compliance home page at www.dell.com/regulatory_compliance.
-  **WARNING:** Disconnect all power sources before opening the computer cover or panels. After you finish working inside the computer, replace all covers, panels, and screws before connecting to the power source.
-  **CAUTION:** To avoid damaging the computer, ensure that the work surface is flat and clean.
-  **CAUTION:** To avoid damaging the components and cards, handle them by their edges and avoid touching pins and contacts.
-  **CAUTION:** You should only perform troubleshooting and repairs as authorized or directed by the Dell technical assistance team. Damage due to servicing that is not authorized by Dell is not covered by your warranty. See the safety instructions that shipped with the product or at www.dell.com/regulatory_compliance.
-  **CAUTION:** Before touching anything inside your computer, ground yourself by touching an unpainted metal surface, such as the metal at the back of the computer. While you work, periodically touch an unpainted metal surface to dissipate static electricity, which could harm internal components.
-  **CAUTION:** When you disconnect a cable, pull on its connector or on its pull tab, not on the cable itself. Some cables have connectors with locking tabs or thumb-screws that you must disengage before disconnecting the cable. When disconnecting cables, keep them evenly aligned to avoid bending any connector pins. When connecting cables, ensure that the ports and connectors are correctly oriented and aligned.
-  **CAUTION:** Press and eject any installed card from the media-card reader.

Recommended tools

The procedures in this document may require the following tools:

- Phillips screwdriver
- Plastic scribe

After working inside your computer



CAUTION: Leaving stray or loose screws inside your computer may severely damage your computer.

- 1 Replace all screws and ensure that no stray screws remain inside your computer.
- 2 Connect any external devices, peripherals, and cables you removed before working on your computer.
- 3 Replace any media cards, discs, and any other parts that you removed before working on your computer.
- 4 Connect your computer and all attached devices to their electrical outlets.
- 5 Turn on your computer.

Technical overview



WARNING: Before working inside your computer, read the safety information that shipped with your computer and follow the steps in [Before working inside your computer](#). After working inside your computer, follow the instructions in [After working inside your computer](#). For more safety best practices, see the Regulatory Compliance home page at www.dell.com/regulatory_compliance.

Inside view of your computer

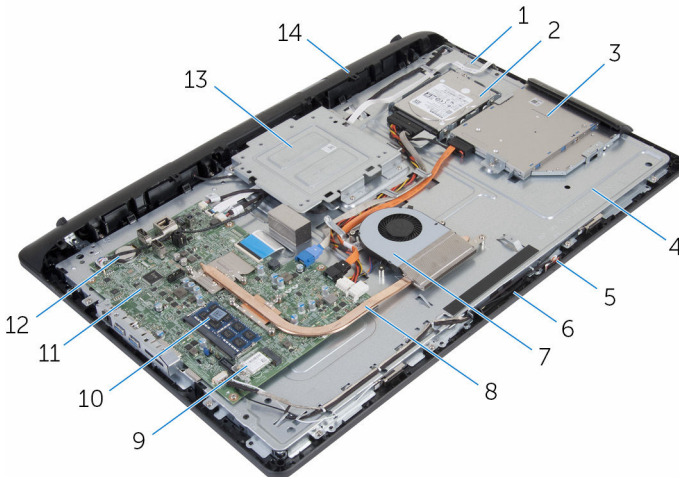

- | | | | |
|----|------------------------|----|-----------------------|
| 1 | control-buttons board | 2 | hard-drive assembly |
| 3 | optical-drive assembly | 4 | display-assembly base |
| 5 | microphone board | 6 | camera module |
| 7 | fan | 8 | heat sink |
| 9 | wireless card | 10 | memory module |
| 11 | system board | 12 | coin-cell battery |
| 13 | VESA-mount bracket | 14 | speaker cover |

Removing the stand assembly

⚠ WARNING: Before working inside your computer, read the safety information that shipped with your computer and follow the steps in [Before working inside your computer](#). After working inside your computer, follow the instructions in [After working inside your computer](#). For more safety best practices, see the Regulatory Compliance home page at www.dell.com/regulatory_compliance.

Procedure

- 1 Using your fingertips, lift the stand cover.
- 2 Slide and remove the stand cover at an angle away from the stand.

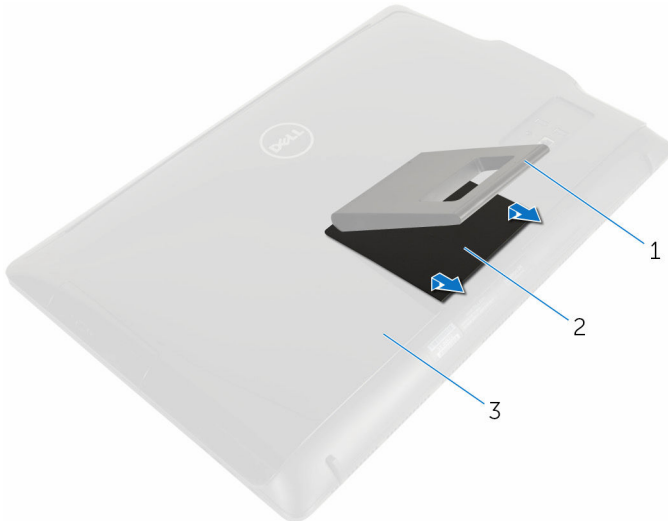

- | | | | |
|---|------------|---|-------------|
| 1 | stand | 2 | stand cover |
| 3 | back cover | | |

- 3 Remove the screws that secure the stand bracket to the back cover.

4 Lift the stand off the back cover.

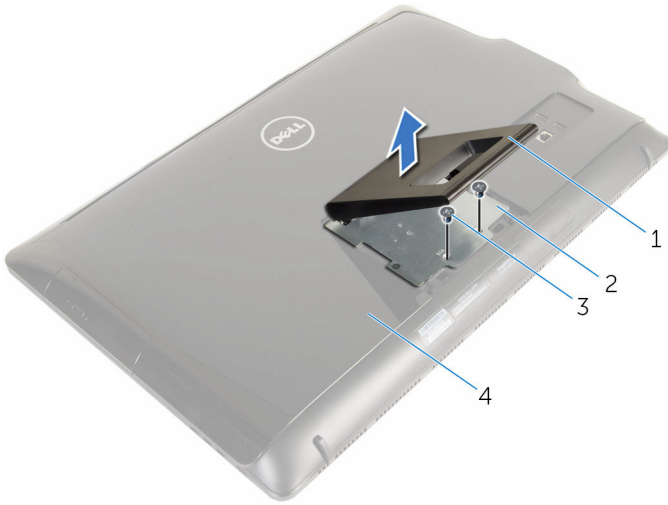

1 stand
3 screws (2)

2 stand bracket
4 back cover

Replacing the stand assembly



WARNING: Before working inside your computer, read the safety information that shipped with your computer and follow the steps in [Before working inside your computer](#). After working inside your computer, follow the instructions in [After working inside your computer](#). For more safety best practices, see the Regulatory Compliance home page at www.dell.com/regulatory_compliance.

Procedure

- 1 Insert the tabs on the stand bracket with the slots on the back cover to align the screw holes on the stand bracket to the screw holes on the back cover.
- 2 Replace the screws that secure the stand bracket to the back cover.
- 3 Slide and replace the stand cover on the stand bracket.

Removing the back cover

 **WARNING:** Before working inside your computer, read the safety information that shipped with your computer and follow the steps in [Before working inside your computer](#). After working inside your computer, follow the instructions in [After working inside your computer](#). For more safety best practices, see the Regulatory Compliance home page at www.dell.com/regulatory_compliance.

Prerequisites

Remove the [stand assembly](#).

Procedure

 **CAUTION:** Do not remove the computer cover unless you need to install internal accessories for your computer.

- 1 Using a plastic scribe, pry the back cover from the display bezel.

2 Lift the back cover off the computer.

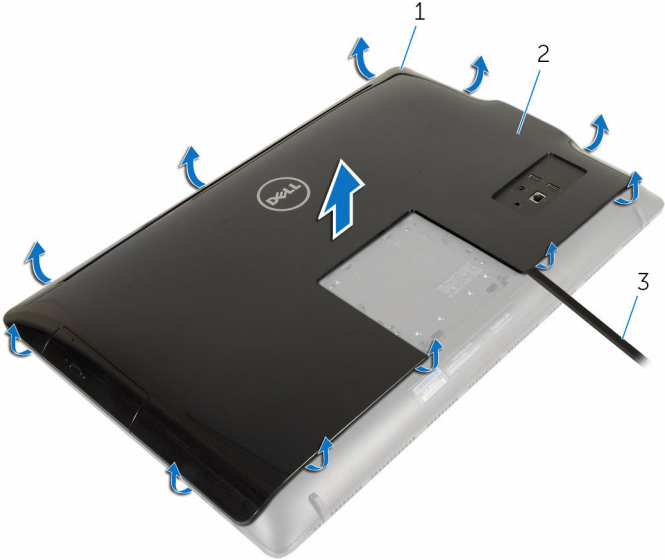

- 1 display bezel
- 3 plastic scribe

- 2 back cover

Replacing the back cover



WARNING: Before working inside your computer, read the safety information that shipped with your computer and follow the steps in [Before working inside your computer](#). After working inside your computer, follow the instructions in [After working inside your computer](#). For more safety best practices, see the Regulatory Compliance home page at www.dell.com/regulatory_compliance.

Procedure

Align the tabs on the back cover with the slots on the display bezel and snap the back cover into place.

Post-requisites

Replace the [stand assembly](#).

Removing the optical drive



WARNING: Before working inside your computer, read the safety information that shipped with your computer and follow the steps in [Before working inside your computer](#). After working inside your computer, follow the instructions in [After working inside your computer](#). For more safety best practices, see the Regulatory Compliance home page at www.dell.com/regulatory_compliance.

Prerequisites

- 1 Remove the [stand assembly](#).
- 2 Remove the [back cover](#).

Procedure

- 1 Disconnect the power and data cable from the optical drive.
- 2 Remove the screw that secures the optical-drive assembly to the display-assembly base.

- 3 Slide the optical-drive assembly out of the optical-drive bay.

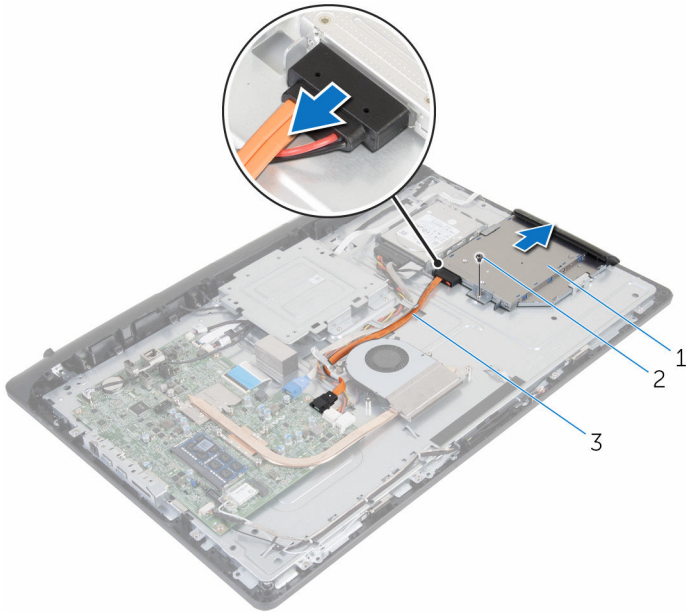

- | | | | |
|---|------------------------|---|-------|
| 1 | optical-drive assembly | 2 | screw |
| 3 | power and data cable | | |

- 4 Carefully pull the optical-drive bezel and remove it from the optical drive.
- 5 Remove the screw that secures the optical-drive bracket to the optical drive.

6 Remove the optical-drive bracket from the optical drive.

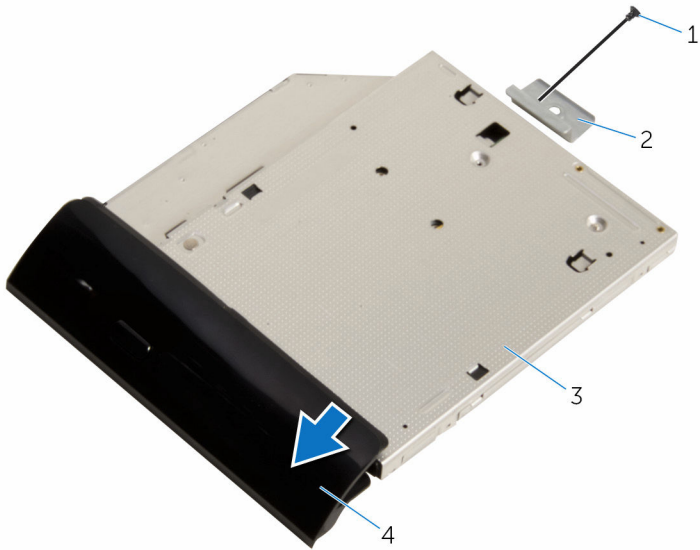

1 screw

3 optical drive

2 optical-drive bracket

4 optical-drive bezel

Replacing the optical drive



WARNING: Before working inside your computer, read the safety information that shipped with your computer and follow the steps in [Before working inside your computer](#). After working inside your computer, follow the instructions in [After working inside your computer](#). For more safety best practices, see the Regulatory Compliance home page at www.dell.com/regulatory_compliance.



Procedure

- 1 Align the screw hole on the optical-drive bracket with the screw hole on the optical drive.
- 2 Replace the screw that secures the optical-drive bracket to the optical drive.
- 3 Align the tabs on the optical-drive bezel with the slots on the optical-drive assembly and snap it into place.
- 4 Slide the optical-drive assembly into the optical-drive bay and align the screw hole on the optical-drive bracket with the screw hole on the display-assembly base.
- 5 Replace the screw that secures the optical-drive assembly to the display-assembly base.
- 6 Connect the power and data cable to the optical-drive assembly.

Post-requisites

- 1 Replace the [back cover](#).
- 2 Replace the [stand assembly](#).

Removing the hard drive

-  **WARNING:** Before working inside your computer, read the safety information that shipped with your computer and follow the steps in [Before working inside your computer](#). After working inside your computer, follow the instructions in [After working inside your computer](#). For more safety best practices, see the Regulatory Compliance home page at www.dell.com/regulatory_compliance.
-  **CAUTION:** Hard drives are fragile. Exercise care when handling the hard drive.
-  **CAUTION:** To avoid data loss, do not remove the hard drive while the computer is in sleep or on state.

Prerequisites

- 1 Remove the [stand assembly](#).
- 2 Remove the [back cover](#).

Procedure

- 1 Disconnect the power and data cable from the hard drive.
- 2 Remove the screw that secures the hard-drive assembly to the display-assembly base.

- 3** Using your fingertips, slide and lift the hard-drive assembly out of the hard-drive bay.

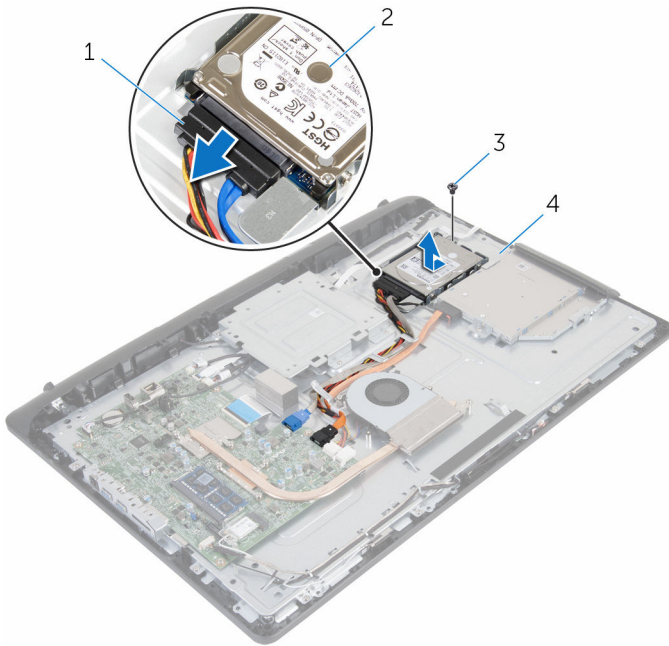

1 power and data cable

2 hard-drive assembly

3 screw

4 display-assembly base

- 4** Remove the screws that secure the hard-drive bracket to the hard drive.

5 Remove the hard drive from the hard-drive bracket.

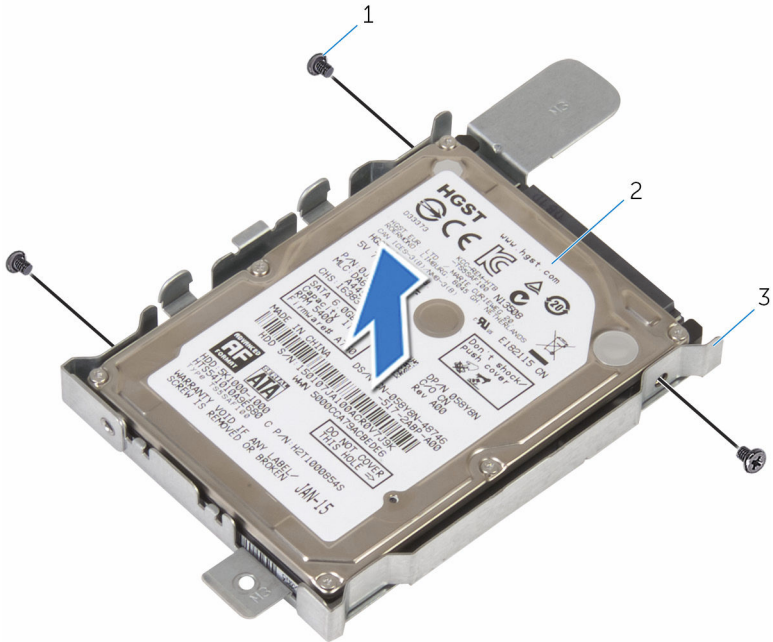



1 screws (3)

2 hard drive

3 hard-drive bracket

Replacing the hard drive

-  **WARNING:** Before working inside your computer, read the safety information that shipped with your computer and follow the steps in [Before working inside your computer](#). After working inside your computer, follow the instructions in [After working inside your computer](#). For more safety best practices, see the Regulatory Compliance home page at www.dell.com/regulatory_compliance.
-  **CAUTION:** Hard drives are fragile. Exercise care when handling the hard drive.

Procedure

- 1 Align the screw holes on the hard-drive bracket with the screw holes on the hard drive.
- 2 Replace the screws that secure the hard-drive bracket to the hard drive.
- 3 Slide the hard-drive assembly into the hard-drive bay and align the screw hole on the hard-drive bracket with the screw hole on the display-assembly base.
- 4 Replace the screw that secures the hard-drive assembly to the display-assembly base.
- 5 Connect the power and data cable to the hard drive.

Post-requisites

- 1 Replace the [back cover](#).
- 2 Replace the [stand assembly](#).

Removing the memory module



WARNING: Before working inside your computer, read the safety information that shipped with your computer and follow the steps in [Before working inside your computer](#). After working inside your computer, follow the instructions in [After working inside your computer](#). For more safety best practices, see the Regulatory Compliance home page at www.dell.com/regulatory_compliance.

Prerequisites

- 1 Remove the [stand assembly](#).
- 2 Remove the [back cover](#).

Procedure

- 1 Use your fingertips to carefully spread apart the securing clips on each end of the memory-module slot until the memory module pops up.

2 Remove the memory module from the memory-module slot.

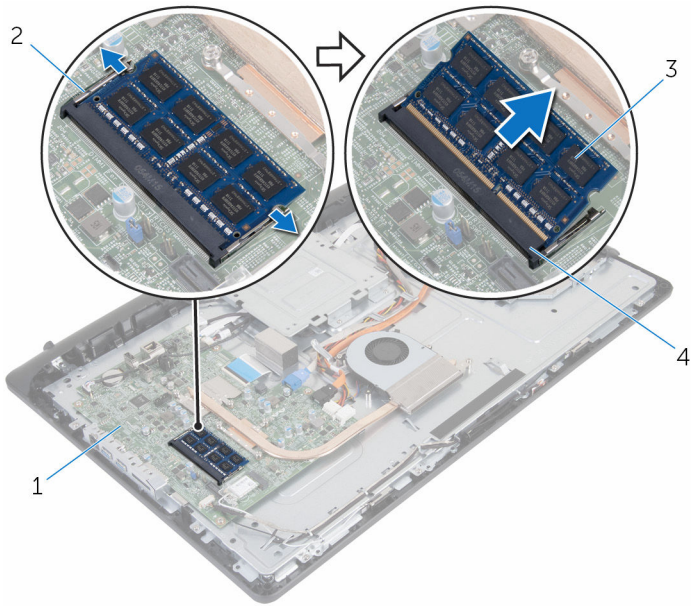

- 1 system board
- 3 memory module

- 2 securing clips (2)
- 4 memory-module slot

Replacing the memory module



WARNING: Before working inside your computer, read the safety information that shipped with your computer and follow the steps in [Before working inside your computer](#). After working inside your computer, follow the instructions in [After working inside your computer](#). For more safety best practices, see the Regulatory Compliance home page at www.dell.com/regulatory_compliance.

Procedure

- 1 Align the notch on the memory module with the tab on the memory-module slot.

- Slide the memory module firmly into the slot at an angle and press the memory module down until it clicks into place.

 **NOTE:** If you do not hear the click, remove the memory module and reinstall it.

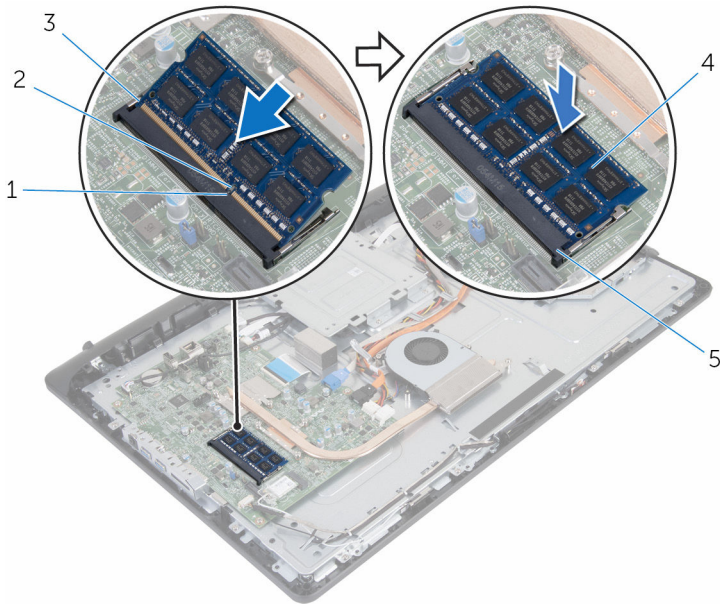

- notch
- securing clips (2)
- memory-module slot

- tab
- memory module

Post-requisites

- Replace the [back cover](#).
- Replace the [stand assembly](#).

Removing the wireless card



WARNING: Before working inside your computer, read the safety information that shipped with your computer and follow the steps in [Before working inside your computer](#). After working inside your computer, follow the instructions in [After working inside your computer](#). For more safety best practices, see the Regulatory Compliance home page at www.dell.com/regulatory_compliance.

Prerequisites

- 1 Remove the [stand assembly](#).
- 2 Remove the [back cover](#).

Procedure

- 1 Remove the screw that secures the wireless-card bracket and the wireless card to the system board.
- 2 Slide the wireless-card bracket off the wireless card.
- 3 Disconnect the antenna cables from the connectors on the wireless card.

4 Slide the wireless card out of the wireless-card slot.

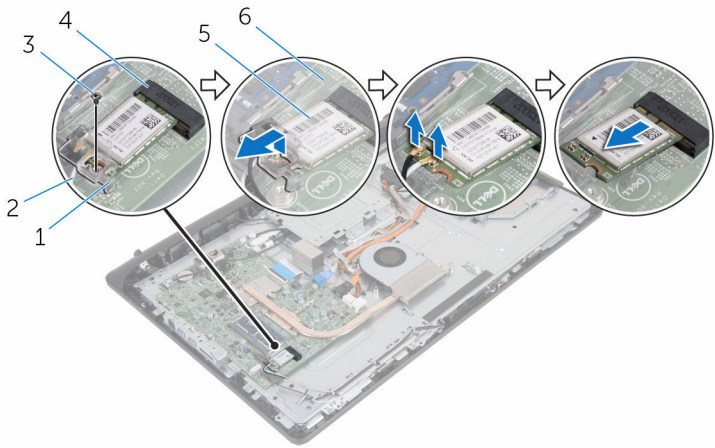

1 wireless-card bracket

2 antenna cables

3 screw

4 wireless-card slot

5 wireless card

6 system board

Replacing the wireless card



WARNING: Before working inside your computer, read the safety information that shipped with your computer and follow the steps in [Before working inside your computer](#). After working inside your computer, follow the instructions in [After working inside your computer](#). For more safety best practices, see the Regulatory Compliance home page at www.dell.com/regulatory_compliance.

Procedure

- 1 Align the notch on the wireless card with the tab on the wireless-card slot.
- 2 Insert the wireless card into the wireless-card slot.
- 3 Press the other end of the wireless card down and align the screw hole on the wireless card with the screw hole on the system board.
- 4 Connect the antenna cables to the wireless card.

The following table provides the antenna-cable color scheme for the wireless card supported by your computer:

Connectors on the wireless card	Antenna-cable color
Main (white triangle)	White
Auxiliary (black triangle)	Black

- 5 Align the screw hole on the wireless-card bracket with the screw hole on the wireless card.

- 6 Replace the screw that secures the wireless-card bracket and the wireless card to the system board.

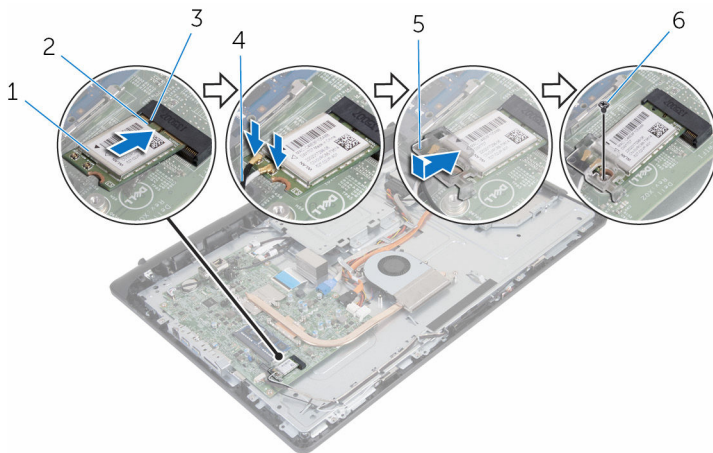

- | | | | |
|---|-----------------------|---|----------------|
| 1 | wireless card | 2 | notch |
| 3 | tab | 4 | antenna cables |
| 5 | wireless-card bracket | 6 | screw |

Post-requisites

- 1 Replace the [back cover](#).
- 2 Replace the [stand assembly](#).

Removing the heat sink

 **WARNING:** Before working inside your computer, read the safety information that shipped with your computer and follow the steps in [Before working inside your computer](#). After working inside your computer, follow the instructions in [After working inside your computer](#). For more safety best practices, see the Regulatory Compliance home page at www.dell.com/regulatory_compliance.

 **WARNING:** The heat sink may become hot during normal operation. Allow sufficient time for the heat sink to cool before you touch it.

 **CAUTION:** For maximum cooling of the processor, do not touch the heat transfer areas on the heat sink. The oils in your skin can reduce the heat transfer capability of the thermal grease.

Prerequisites

- 1 Remove the [stand assembly](#).
- 2 Remove the [back cover](#).

Procedure

- 1 In sequential order (as indicated on the heat sink), loosen the captive screws that secure the heat sink to the system board.
- 2 Remove the screw that secures the heat sink to the display-assembly base.

3 Lift the heat sink off the system board.

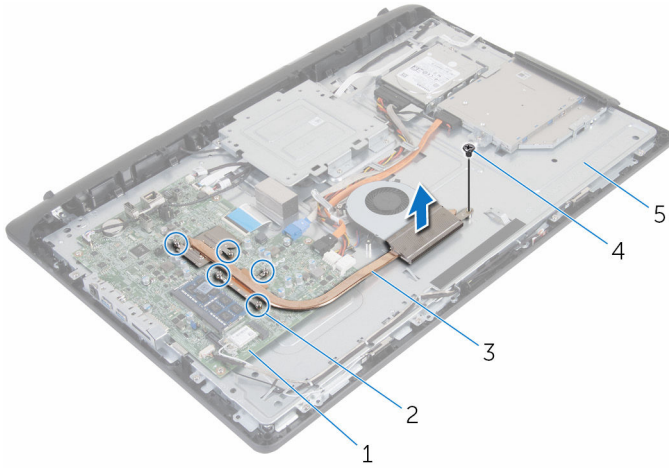

1 system board

2 captive screws (5)

3 heat sink

4 screw

5 display-assembly base

Replacing the heat sink

 **WARNING:** Before working inside your computer, read the safety information that shipped with your computer and follow the steps in [Before working inside your computer](#). After working inside your computer, follow the instructions in [After working inside your computer](#). For more safety best practices, see the Regulatory Compliance home page at www.dell.com/regulatory_compliance.

 **CAUTION:** Incorrect alignment of the heat sink can cause damage to the system board and processor.

 **NOTE:** The original thermal grease can be reused if the original system board and heat sink are reinstalled together. If either the system board or the heat sink is replaced, use the thermal pad provided in the kit to ensure that thermal conductivity is achieved.

Procedure

- 1 Align the screw hole on the heat sink with the screw hole on the display-assembly base.
- 2 Align the captive screws on the heat sink with the screw holes on the system board.
- 3 In sequential order (as indicated on the heat sink), tighten the captive screws that secure the heat sink to the system board.
- 4 Replace the screw that secures the heat sink to the display-assembly base.

Post-requisites

- 1 Replace the [back cover](#).
- 2 Replace the [stand assembly](#).

Removing the fan



WARNING: Before working inside your computer, read the safety information that shipped with your computer and follow the steps in [Before working inside your computer](#). After working inside your computer, follow the instructions in [After working inside your computer](#). For more safety best practices, see the Regulatory Compliance home page at www.dell.com/regulatory_compliance.

Prerequisites

- 1 Remove the [stand assembly](#).
- 2 Remove the [back cover](#).

Procedure

- 1 Disconnect the fan cable from the system board.
- 2 Remove the screws that secure the fan to the display-assembly base.

3 Lift the fan at an angle off the display-assembly base.

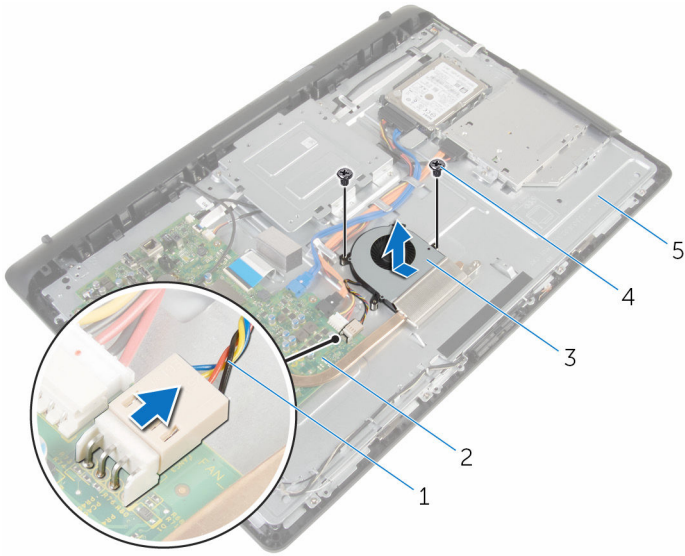

- | | | | |
|---|-----------------------|---|--------------|
| 1 | fan cable | 2 | system board |
| 3 | fan | 4 | screws (2) |
| 5 | display-assembly base | | |

Replacing the fan



WARNING: Before working inside your computer, read the safety information that shipped with your computer and follow the steps in [Before working inside your computer](#). After working inside your computer, follow the instructions in [After working inside your computer](#). For more safety best practices, see the Regulatory Compliance home page at www.dell.com/regulatory_compliance.



Procedure

- 1 Replace the fan at an angle on the display-assembly base.
- 2 Align the screw holes on the fan with the screw holes on the display-assembly base.
- 3 Replace the screws that secure the fan to the display-assembly base.
- 4 Connect the fan cable to the system board.

Post-requisites

- 1 Replace the [back cover](#).
- 2 Replace the [stand assembly](#).

Removing the coin-cell battery

-  **WARNING:** Before working inside your computer, read the safety information that shipped with your computer and follow the steps in [Before working inside your computer](#). After working inside your computer, follow the instructions in [After working inside your computer](#). For more safety best practices, see the Regulatory Compliance home page at www.dell.com/regulatory_compliance.
-  **CAUTION:** Removing the coin-cell battery resets the BIOS setup program's settings to default. It is recommended that you note the BIOS setup program's settings before removing the coin-cell battery.

Prerequisites

- 1 Remove the [stand assembly](#).
- 2 Remove the [back cover](#).

Procedure

Using a plastic scribe, gently pry out the coin-cell battery out of the battery socket on the system board.

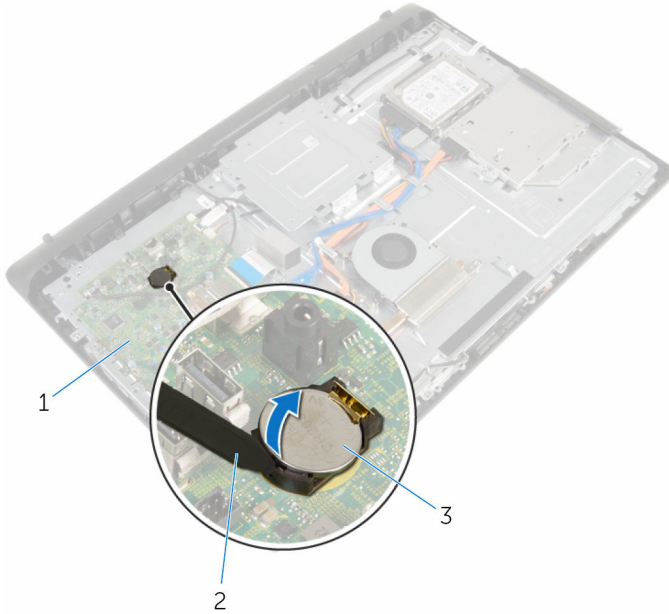

- 1 system board
- 3 coin-cell battery

- 2 plastic scribe

Replacing the coin-cell battery



WARNING: Before working inside your computer, read the safety information that shipped with your computer and follow the steps in [Before working inside your computer](#). After working inside your computer, follow the instructions in [After working inside your computer](#). For more safety best practices, see the Regulatory Compliance home page at www.dell.com/regulatory_compliance.

Procedure

With the positive-side facing up, insert the coin-cell battery into the battery socket and press down the battery into place.

Post-requisites

- 1 Replace the [back cover](#).
- 2 Replace the [stand assembly](#).

Removing the microphone



WARNING: Before working inside your computer, read the safety information that shipped with your computer and follow the steps in [Before working inside your computer](#). After working inside your computer, follow the instructions in [After working inside your computer](#). For more safety best practices, see the Regulatory Compliance home page at www.dell.com/regulatory_compliance.

Prerequisites

- 1 Remove the [stand assembly](#).
- 2 Remove the [back cover](#).

Procedure

- 1 Disconnect the microphone and camera cable from the system board.
- 2 Note the microphone and camera cable routing and remove the cable from its routing guides on the display-assembly base.
- 3 Follow the procedure from step 4 to step 7 in "[Removing the camera](#)".
- 4 Lift the microphone board at an angle off the display bezel.

- 5 Disconnect the microphone and camera cable from the microphone board.

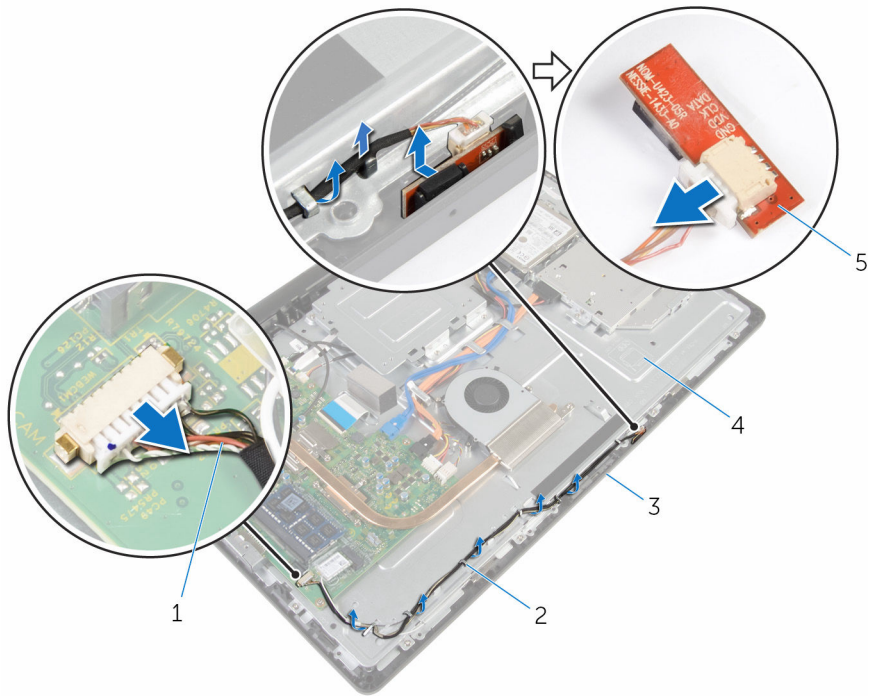

- | | | | |
|---|-----------------------------|---|-----------------------|
| 1 | microphone and camera cable | 2 | routing guides |
| 3 | display bezel | 4 | display-assembly base |
| 5 | microphone board | | |

Replacing the microphone



WARNING: Before working inside your computer, read the safety information that shipped with your computer and follow the steps in [Before working inside your computer](#). After working inside your computer, follow the instructions in [After working inside your computer](#). For more safety best practices, see the Regulatory Compliance home page at www.dell.com/regulatory_compliance.

Procedure

- 1 Connect the microphone and camera cable to the microphone-board.
- 2 Slide the microphone board into the slot on the display bezel.
- 3 Follow the procedure from step 1 to step 3 in "[Replacing the camera](#)".
- 4 Route the microphone and camera cable through the routing guides on the display-assembly base.
- 5 Connect the microphone and camera cable to the system board.

Post-requisites

- 1 Replace the [back cover](#).
- 2 Replace the [stand assembly](#).

Removing the camera



WARNING: Before working inside your computer, read the safety information that shipped with your computer and follow the steps in [Before working inside your computer](#). After working inside your computer, follow the instructions in [After working inside your computer](#). For more safety best practices, see the Regulatory Compliance home page at www.dell.com/regulatory_compliance.

Prerequisites

- 1 Remove the [stand assembly](#).
- 2 Remove the [back cover](#).

Procedure

- 1 Disconnect the microphone and camera cable from the system board.
- 2 Note the microphone and camera cable routing and remove the cable from its routing guides on the display-assembly base.
- 3 Follow the procedure from step 4 to step 6 in "[Removing the microphone](#)".
- 4 Using your fingertips, press the securing clip and lift the camera module.
- 5 Disconnect the camera module from the tab on the camera module-slot on the display bezel.
- 6 Lift the camera module away from the display bezel.

7 Disconnect the microphone and camera cable from the camera module.

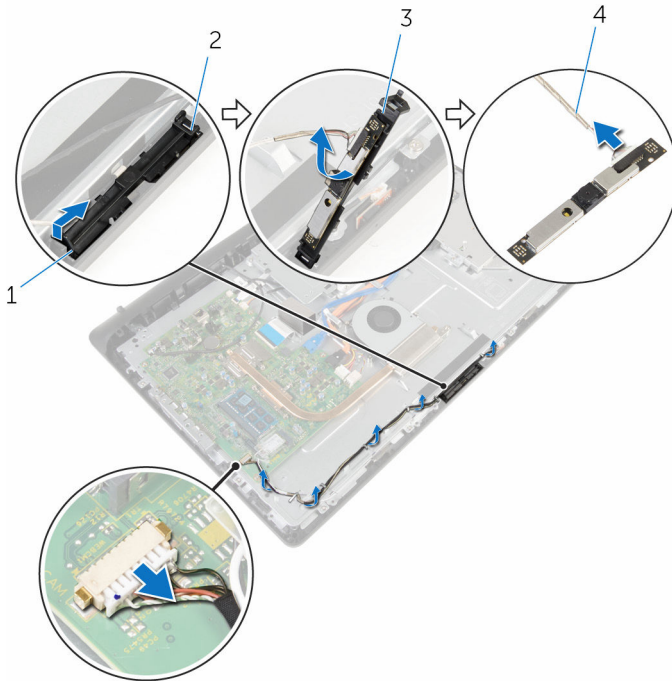

- 1 securing clip
- 3 camera module

- 2 tab
- 4 microphone and camera cable

Replacing the camera



WARNING: Before working inside your computer, read the safety information that shipped with your computer and follow the steps in [Before working inside your computer](#). After working inside your computer, follow the instructions in [After working inside your computer](#). For more safety best practices, see the Regulatory Compliance home page at www.dell.com/regulatory_compliance.

Procedure

- 1 Connect the microphone and camera cable to the camera module.
- 2 Push the tabs on the camera module into the tab on the camera-module slot.
- 3 Press the camera module down into the slot on the display bezel until it snaps into place.
- 4 Follow the procedure from step 1 to step 2 in "[Replacing the microphone](#)".
- 5 Route the microphone and camera cable through the routing guides on the display-assembly base.
- 6 Connect the microphone and camera cable to the system board.

Post-requisites

- 1 Replace the [back cover](#).
- 2 Replace the [stand assembly](#).

Removing the system board



WARNING: Before working inside your computer, read the safety information that shipped with your computer and follow the steps in [Before working inside your computer](#). After working inside your computer, follow the instructions in [After working inside your computer](#). For more safety best practices, see the Regulatory Compliance home page at www.dell.com/regulatory_compliance.



NOTE: Your computer's Service Tag is stored in the system board. You must enter the Service Tag in the BIOS setup program after you replace the system board.



NOTE: Replacing the system board removes any changes you have made to the BIOS using the BIOS setup program. You must make the desired changes again after you replace the system board.



NOTE: Before disconnecting the cables from the system board, note the location of the connectors so that you can reconnect the cables correctly after you replace the system board.

Prerequisites

- 1 Remove the [stand assembly](#).
- 2 Remove the [back cover](#).
- 3 Remove the [memory module](#).
- 4 Remove the [heat sink](#).
- 5 Remove the [wireless card](#).

Procedure

- 1 Disconnect the speaker, touch-control board, hard-drive data, optical-drive data, hard-drive and optical-drive power, fan, and microphone and camera cables from its connectors on the system board.
- 2 Lift the latches and disconnect the control-buttons board and display cables from its connectors on the system board.

- 3** Press the latch and disconnect the display-backlight cable from its connector on the system board.

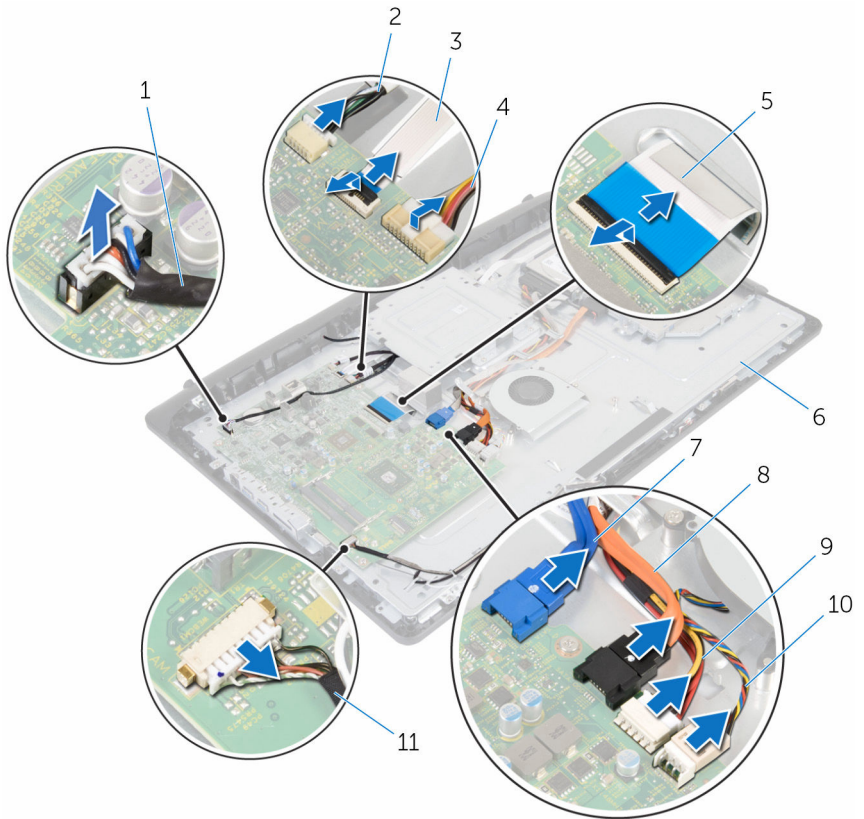

- | | | | |
|----|--|----|---------------------------|
| 1 | speaker cable | 2 | touch-control board cable |
| 3 | control-buttons board cable | 4 | display-backlight cable |
| 5 | display cable | 6 | display-assembly base |
| 7 | hard-drive data cable | 8 | optical-drive data cable |
| 9 | hard-drive and optical-drive power cable | 10 | fan cable |
| 11 | microphone and camera cable | | |

- 4** Remove the screws that secure the system board to the display-assembly base.

- 5 Carefully lift the system board from the inner edge and release the ports from the slots on the display-assembly base.
- 6 Lift the system board off the display-assembly base.

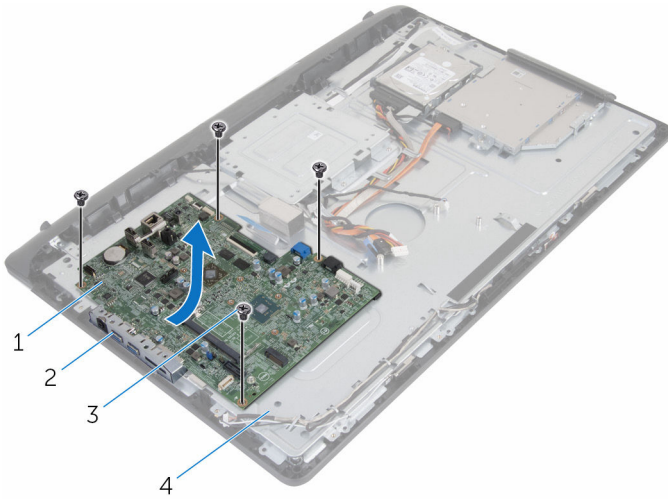

1 system board
3 screws (4)

2 slots
4 display-assembly base

Replacing the system board



WARNING: Before working inside your computer, read the safety information that shipped with your computer and follow the steps in [Before working inside your computer](#). After working inside your computer, follow the instructions in [After working inside your computer](#). For more safety best practices, see the Regulatory Compliance home page at www.dell.com/regulatory_compliance.



NOTE: Your computer's Service Tag is stored in the system board. You must enter the Service Tag in the BIOS setup program after you replace the system board.



NOTE: Replacing the system board removes any changes you have made to the BIOS using the BIOS setup program. You must make the desired changes again after you replace the system board.

Procedure

- 1 Slide the ports on the system board into the slots on the display-assembly base and place the system board on the display-assembly base.
- 2 Align the screw holes on the system board with the screw holes on the display-assembly base.
- 3 Replace the screws that secure the system board to the display-assembly base.
- 4 Connect the display-backlight cable to its connector on the system board.
- 5 Slide the control-buttons board and display cables into its connectors on the system board and press down on the latches to secure the cables.
- 6 Connect the speaker, touch-control board, hard-drive data, optical-drive data, hard-drive and optical-drive power, fan, and microphone and camera cables to its connectors on the system board.

Post-requisites

- 1 Replace the [wireless card](#).
- 2 Replace the [heat sink](#).
- 3 Replace the [memory module](#).
- 4 Replace the [back cover](#).

5 Replace the [stand assembly](#).

Removing the VESA-mount bracket



WARNING: Before working inside your computer, read the safety information that shipped with your computer and follow the steps in [Before working inside your computer](#). After working inside your computer, follow the instructions in [After working inside your computer](#). For more safety best practices, see the Regulatory Compliance home page at www.dell.com/regulatory_compliance.

Prerequisites

- 1 Remove the [stand assembly](#).
- 2 Remove the [back cover](#).

Procedure

- 1 Note the speaker cable routing under the VESA-mount bracket and remove it from the routing guides.
- 2 Remove the screws that secure the VESA-mount bracket to the display-assembly base.

3 Lift the VESA-mount bracket off the display-assembly base.

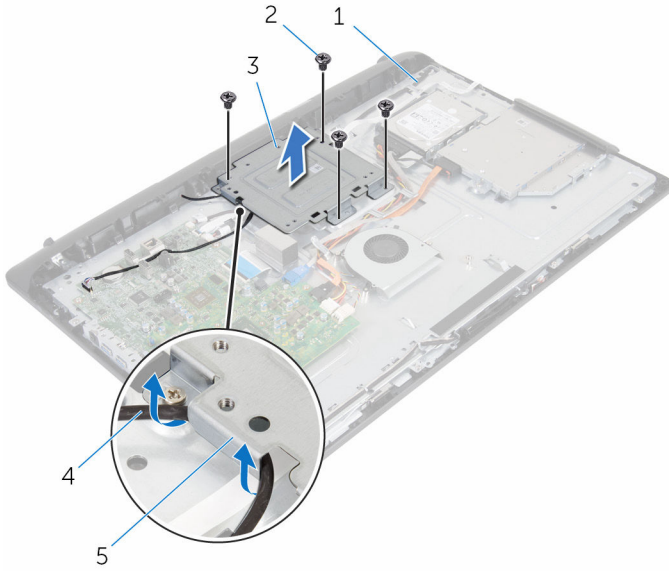

- 1 display-assembly base
- 3 VESA-mount bracket
- 5 routing guides

- 2 screws (4)
- 4 speaker cable

Replacing the VESA-mount bracket

 **WARNING:** Before working inside your computer, read the safety information that shipped with your computer and follow the steps in [Before working inside your computer](#). After working inside your computer, follow the instructions in [After working inside your computer](#). For more safety best practices, see the Regulatory Compliance home page at www.dell.com/regulatory_compliance.

Procedure

- 1 Align the screw holes on the VESA-mount bracket with the screw holes on the display-assembly base.
- 2 Replace the screws that secure the VESA-mount bracket to the display-assembly base.
- 3 Route the speaker cable through the routing guides under the VESA-mount bracket.

Post-requisites

- 1 Replace the [back cover](#).
- 2 Replace the [stand assembly](#).

Removing the speaker cover



WARNING: Before working inside your computer, read the safety information that shipped with your computer and follow the steps in [Before working inside your computer](#). After working inside your computer, follow the instructions in [After working inside your computer](#). For more safety best practices, see the Regulatory Compliance home page at www.dell.com/regulatory_compliance.

Prerequisites

- 1 Remove the [stand assembly](#).
- 2 Remove the [back cover](#).

Procedure

- 1 Remove the screws that secure the speaker cover to the display-assembly base.
- 2 Using your fingertips, pry the speaker cover from the display-assembly base.

3 Lift the speaker cover off the display bezel.

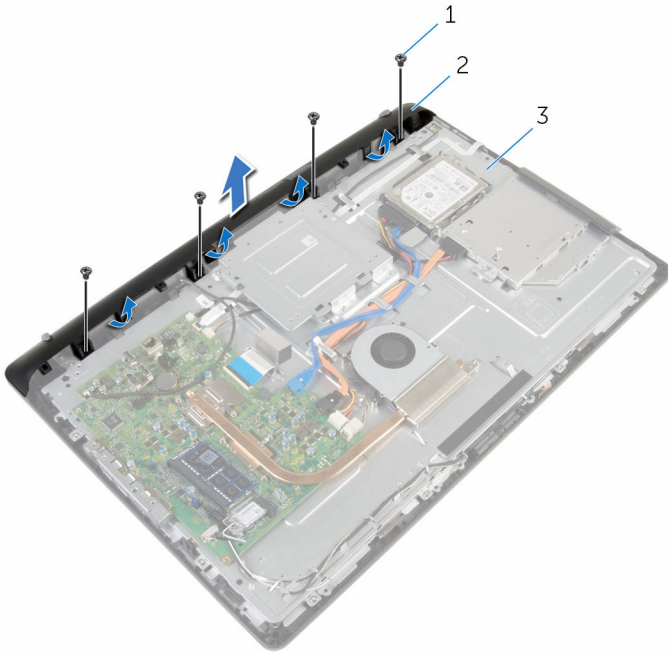

1 screws (4)

2 speaker cover

3 display-assembly base

Replacing the speaker cover



WARNING: Before working inside your computer, read the safety information that shipped with your computer and follow the steps in [Before working inside your computer](#). After working inside your computer, follow the instructions in [After working inside your computer](#). For more safety best practices, see the Regulatory Compliance home page at www.dell.com/regulatory_compliance.

Procedure

- 1 Align the screw holes on the speaker cover with the screw holes on the display-assembly base and snap the speaker cover into place.
- 2 Replace the screws that secure the speaker cover to the display-assembly base.

Post-requisites

- 1 Replace the [back cover](#).
- 2 Replace the [stand assembly](#).

Removing the speakers



WARNING: Before working inside your computer, read the safety information that shipped with your computer and follow the steps in [Before working inside your computer](#). After working inside your computer, follow the instructions in [After working inside your computer](#). For more safety best practices, see the Regulatory Compliance home page at www.dell.com/regulatory_compliance.

Prerequisites

- 1 Remove the [stand assembly](#).
- 2 Remove the [back cover](#).
- 3 Remove the [speaker cover](#).

Procedure

- 1 Disconnect the speaker cable from the system board.
- 2 Note the speaker-cable routing on the display-panel base.
- 3 Remove the speaker cable at an angle from the VESA-mount bracket.
- 4 Remove the screw from the VESA-mount bracket.
- 5 Peel off the tape that secures the speaker cable to the VESA-mount bracket.
- 6 Note the routing of the speaker cable connecting the left speaker to the right speaker and the position of the rubber grommets on the computer bezel.

7 Lift the speakers, along with the speaker cable, off the display bezel.

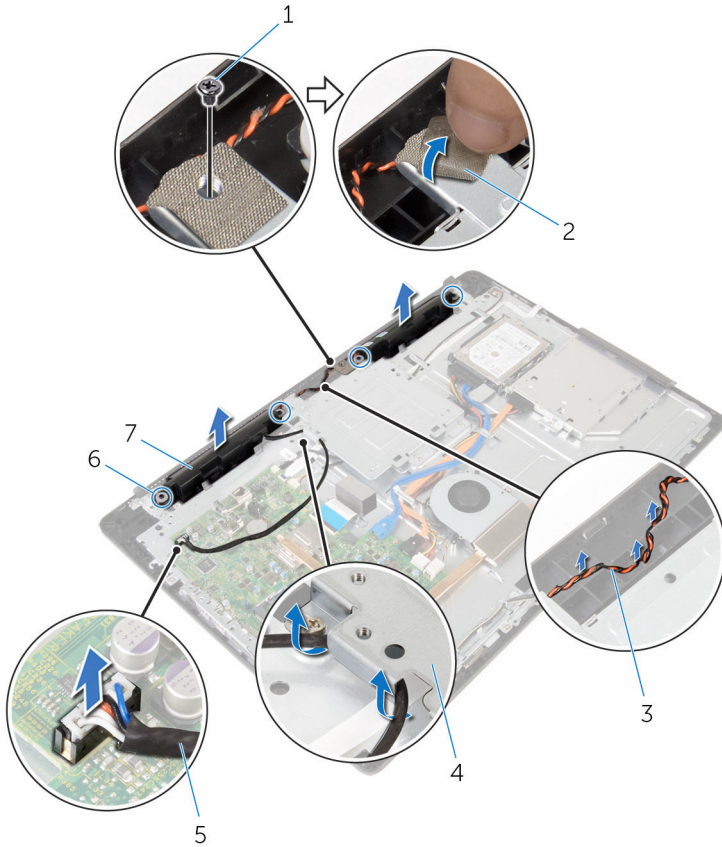

1 screw

2 tape

3 speaker-cable routing

4 VESA-mount bracket

5 speaker cable

6 rubber grommets (4)

7 speakers (2)

Replacing the speakers



WARNING: Before working inside your computer, read the safety information that shipped with your computer and follow the steps in [Before working inside your computer](#). After working inside your computer, follow the instructions in [After working inside your computer](#). For more safety best practices, see the Regulatory Compliance home page at www.dell.com/regulatory_compliance.

Procedure

- 1 Using the alignment posts and rubber grommets on the display bezel, place the speakers on the display bezel.
- 2 Route the speaker cable through the routing guide on the display bezel.
- 3 Adhere the tape that secures the speaker cable to the VESA-mount bracket.
- 4 Replace the screw to the VESA-mount bracket.
- 5 Replace the rubber grommets if they are pushed up while replacing the speakers.
- 6 Route the speaker cable connecting the left speaker to the right speaker on the display-panel base.
- 7 Route and replace the speaker cable under the VESA-mount bracket.
- 8 Connect the speaker cable to the system board.

Post-requisites

- 1 Replace the [speaker cover](#).
- 2 Replace the [back cover](#).
- 3 Replace the [stand assembly](#).

Removing the control-buttons board



WARNING: Before working inside your computer, read the safety information that shipped with your computer and follow the steps in [Before working inside your computer](#). After working inside your computer, follow the instructions in [After working inside your computer](#). For more safety best practices, see the Regulatory Compliance home page at www.dell.com/regulatory_compliance.

Prerequisites

- 1 Remove the [stand assembly](#).
- 2 Remove the [back cover](#).
- 3 Remove the [VESA-mount bracket](#).

Procedure

- 1 Lift the latch and disconnect the control-buttons board cable from the system board.
- 2 Note the control-buttons board cable routing and peel it off from its routing guides on the display-assembly base.
- 3 Using your fingertips, press the securing clips on the control-buttons board slot.
- 4 Lift the control-buttons board off the display bezel.

- 5 Lift the latch and disconnect the control-buttons board cable from the control-buttons board.

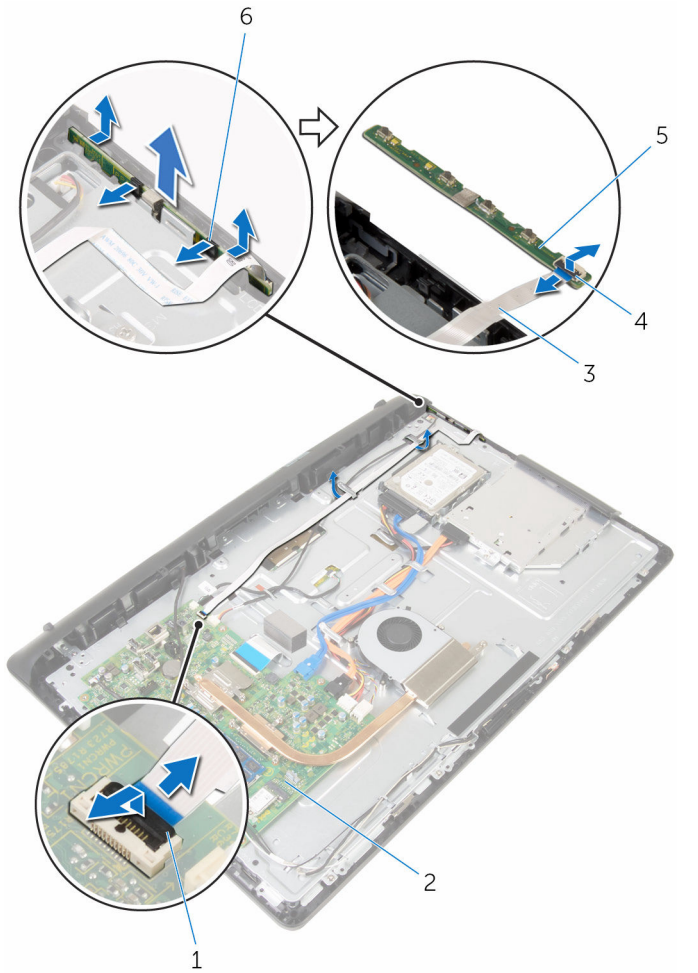

- | | | | |
|---|-----------------------------|---|--------------------|
| 1 | latch | 2 | system board |
| 3 | control-buttons board cable | 4 | latch |
| 5 | control-buttons board | 6 | securing clips (2) |

Replacing the control-buttons board

 **WARNING:** Before working inside your computer, read the safety information that shipped with your computer and follow the steps in [Before working inside your computer](#). After working inside your computer, follow the instructions in [After working inside your computer](#). For more safety best practices, see the Regulatory Compliance home page at www.dell.com/regulatory_compliance.

Procedure

- 1 Slide the control-buttons board cable into the connector on the control-buttons board and press down on the latch to secure the cable.
- 2 Replace the control-buttons board into the slot on the display bezel.
- 3 Route the control-buttons board cable through the routing guides and adhere the control-buttons board cable to the display-assembly base.
- 4 Slide the control-buttons board cable into the connector on the systems board and press down on the latch to secure the cable.

Post-requisites

- 1 Replace the [VESA-mount bracket](#).
- 2 Replace the [back cover](#).
- 3 Replace the [stand assembly](#).

Removing the display assembly



WARNING: Before working inside your computer, read the safety information that shipped with your computer and follow the steps in [Before working inside your computer](#). After working inside your computer, follow the instructions in [After working inside your computer](#). For more safety best practices, see the Regulatory Compliance home page at www.dell.com/regulatory_compliance.

Prerequisites

- 1 Remove the [stand assembly](#).
- 2 Remove the [back cover](#).
- 3 Remove the [optical drive](#).
- 4 Remove the [hard drive](#).
- 5 Remove the [memory module](#).
- 6 Remove the [wireless card](#).
- 7 Remove the [heat sink](#).
- 8 Remove the [fan](#).
- 9 Remove the [microphone](#).
- 10 Remove the [camera](#).
- 11 Remove the [system board](#).
- 12 Remove the [VESA-mount bracket](#).
- 13 Remove the [speaker cover](#).
- 14 Remove the [speakers](#).
- 15 Remove the [control-buttons board](#).

Procedure

- 1 Note the optical drive and hard drive cables' routing and remove the cables from its routing guides on the display-assembly base.

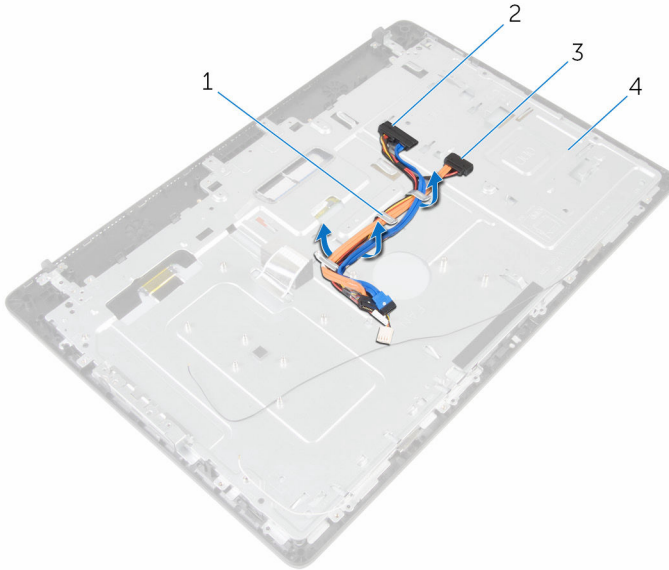

- | | | | |
|---|---------------------|---|-----------------------|
| 1 | routing guides | 2 | hard-drive cable |
| 3 | optical-drive cable | 4 | display-assembly base |

- 2 Remove the screws that secure the display-assembly base to the display bezel.

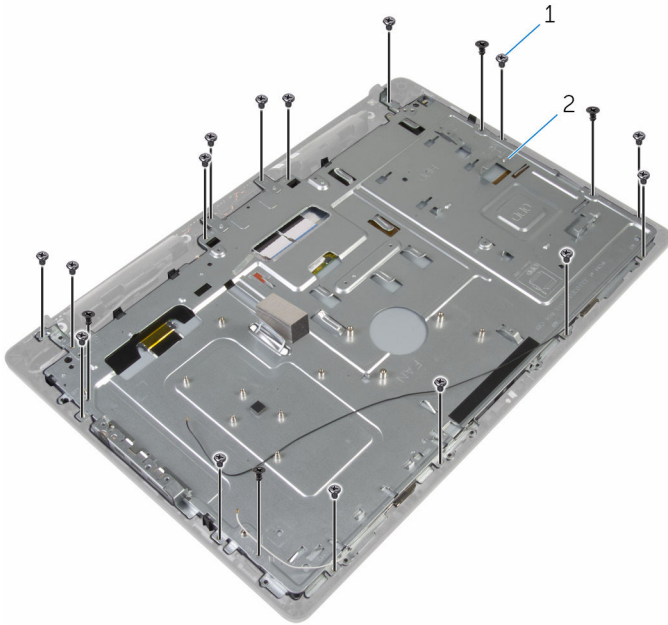

1 screws (19)

2 display-assembly base

- 3 Release the display-panel base from the tabs on the display bezel.
- 4 Slide the display cable through the slot on the display-assembly base.

5 Lift the display-assembly base off the display panel.

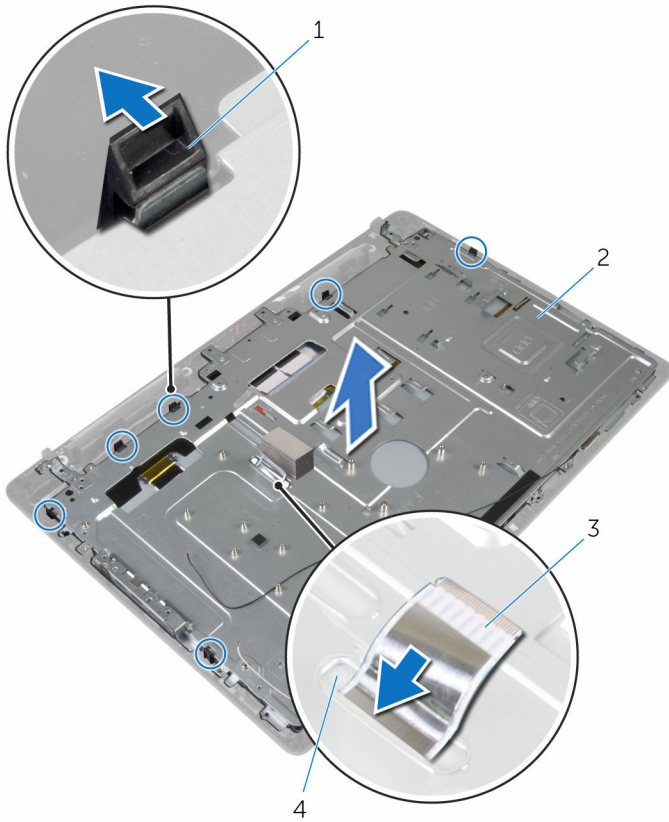

1 tabs (6)

3 display cable

2 display-assembly base

4 slot

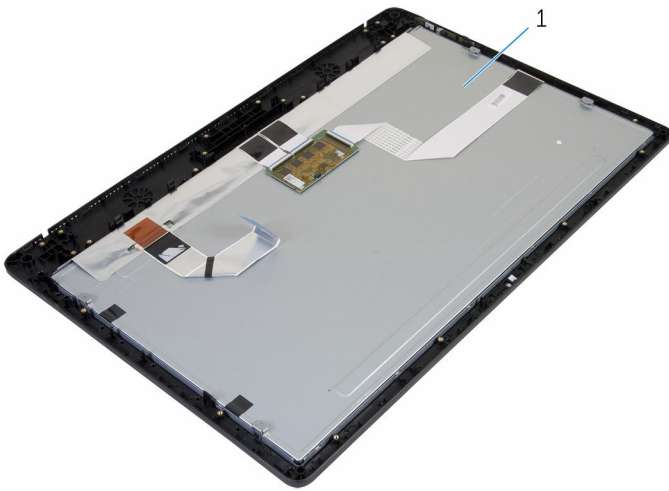

1 display assembly

Replacing the display assembly



WARNING: Before working inside your computer, read the safety information that shipped with your computer and follow the steps in [Before working inside your computer](#). After working inside your computer, follow the instructions in [After working inside your computer](#). For more safety best practices, see the Regulatory Compliance home page at www.dell.com/regulatory_compliance.

Procedure

- 1 Slide the display cable through the slot on the display-assembly base.
- 2 Slide the tabs on the display bezel into the slots on the display-assembly base.
- 3 Replace the display-assembly base on the display bezel.
- 4 Replace the screws that secure the display-assembly base to the display bezel.
- 5 Route the optical drive and hard drive cables through the routing guides on the display-assembly base.

Post-requisites

- 1 Replace the [control-buttons board](#).
- 2 Replace the [speakers](#).
- 3 Replace the [speaker cover](#).
- 4 Replace the [VESA-mount bracket](#).
- 5 Replace the [system board](#).
- 6 Replace the [camera](#).
- 7 Replace the [microphone](#).
- 8 Replace the [fan](#).
- 9 Replace the [heat sink](#).
- 10 Replace the [wireless card](#).
- 11 Replace the [memory module](#).
- 12 Replace the [hard drive](#).
- 13 Replace the [optical drive](#).
- 14 Replace the [back cover](#).

15 Replace the [stand assembly](#).

Removing the rubber feet



WARNING: Before working inside your computer, read the safety information that shipped with your computer and follow the steps in [Before working inside your computer](#). After working inside your computer, follow the instructions in [After working inside your computer](#). For more safety best practices, see the Regulatory Compliance home page at www.dell.com/regulatory_compliance.

Prerequisites

- 1 Remove the [stand assembly](#).
- 2 Remove the [back cover](#).
- 3 Remove the [optical drive](#).
- 4 Remove the [hard drive](#).
- 5 Remove the [memory module](#).
- 6 Remove the [wireless card](#).
- 7 Remove the [heat sink](#).
- 8 Remove the [fan](#).
- 9 Remove the [microphone](#).
- 10 Remove the [camera](#).
- 11 Remove the [system board](#).
- 12 Remove the [VESA-mount bracket](#).
- 13 Remove the [speaker cover](#).
- 14 Remove the [speakers](#).
- 15 Remove the [control-buttons board](#).
- 16 Remove the [display assembly](#).

Procedure

- 1 Remove the screws that secure the rubber feet to the display bezel.

2 Lift the rubber feet off the display bezel.

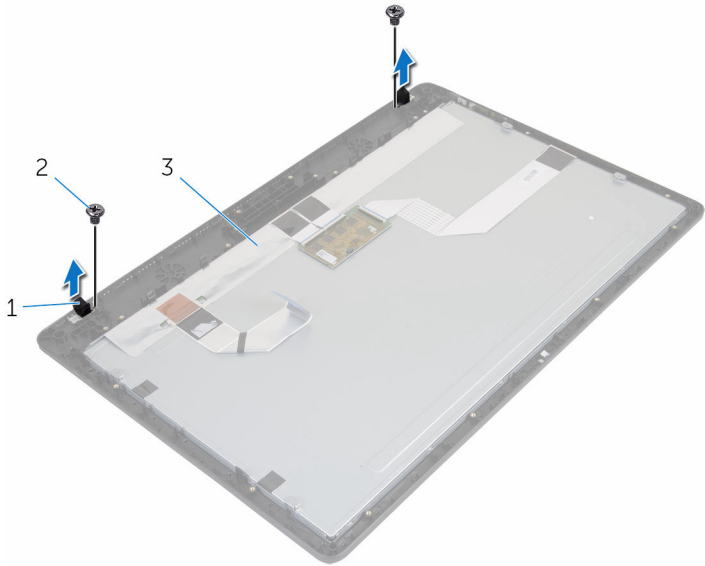

1 rubber feet (2)
3 display bezel

2 screws (2)

Replacing the rubber feet



WARNING: Before working inside your computer, read the safety information that shipped with your computer and follow the steps in [Before working inside your computer](#). After working inside your computer, follow the instructions in [After working inside your computer](#). For more safety best practices, see the Regulatory Compliance home page at www.dell.com/regulatory_compliance.

Procedure

- 1 Align the screw holes on the rubber feet with the screw holes on the display bezel.
- 2 Replace the screws that secure the rubber feet to the display bezel.

Post-requisites

- 1 Replace the [display assembly](#).
- 2 Replace the [control-buttons board](#).
- 3 Replace the [speakers](#).
- 4 Replace the [speaker cover](#).
- 5 Replace the [VESA-mount bracket](#).
- 6 Replace the [system board](#).
- 7 Replace the [camera](#).
- 8 Replace the [microphone](#).
- 9 Replace the [fan](#).
- 10 Replace the [heat sink](#).
- 11 Replace the [wireless card](#).
- 12 Replace the [memory module](#).
- 13 Replace the [hard drive](#).
- 14 Replace the [optical drive](#).
- 15 Replace the [back cover](#).
- 16 Replace the [stand assembly](#).

Flashing the BIOS

You may need to flash (update) the BIOS when an update is available or when you replace the system board. To flash the BIOS:

- 1 Turn on the computer.
- 2 Go to **www.dell.com/support**.
- 3 Click **Product Support**, enter the Service Tag of your computer and click **Submit**.
 **NOTE:** If you do not have the Service Tag, use the auto-detect feature or manually browse for your computer model.
- 4 Click **Drivers & downloads**.
- 5 Select the operating system installed on your computer.
- 6 Scroll down the page and expand **BIOS**.
- 7 Click **Download File** to download the latest version of the BIOS for your computer.
- 8 Save the file and, once the download is complete, navigate to the folder where you saved the BIOS update file.
- 9 Double-click the BIOS update file icon and follow the instructions on the screen.